

# SPECIFICATION

Device Name : SILICON DIODE

Type Name : ESAD92M-03RR

Spec. No. : MS5D3003

This material and the information herein is the property of Fuji Electric Device Technology Co.,Ltd. They shall be neither reproduced, copied, lent, or disclosed in any way whatsoever for the use of any third party nor used for the manufacturing purposes without the express written consent of Fuji Electric Device Technology Co.,Ltd.

	DATE	NAME	APPROVED	
DRAWN	FEB.-20-'07	<i>M. Chinose</i>		Fuji Electric Device Technology Co.,Ltd.
CHECKED	FEB.-20-'07	<i>T. Watabe</i>	<i>T. HOSEA</i>	
CHECKED	FEB.-20-'07	<i>O. Yamada</i>		
				DWGNO. <span style="font-size: 1.2em;">MS5D3003</span> <span style="font-size: 1.2em;">1/12</span>

# Revised Records

Date	Classi- fication	Ind.	Content	Applied date	Drawn	Checked		Approved
FEB.-20 -2007	Enactment	—	_____	Issued date	<i>Mr. Shinose</i>	<i>T. Watabe</i>	<i>O. Yamada</i>	<i>T. HOFER</i>

This material and the information herein is the property of Fuji Electric Device Technology Co., Ltd. They shall be neither reproduced, copied, lent, or disclosed in any way whatsoever for the use of any third party nor used for the manufacturing purposes without the express written consent of Fuji Electric Device Technology Co., Ltd.

Fuji Electric Device Technology Co., Ltd.

DWGNO.

MS5D3003 2/12

**1. SCOPE**

This specification provides the ratings and the test requirement for FUJI SILICON DIODE  
ESAD92M-03RR

**2. OUT VIEW , MARKING , MOLDING RESIN , CHARACTERISTICS**

- (1) Out view is shown           MS5D3003     9/12
- (2) Marking is shown           MS5D3003     9/12  
It is marked to type name or abbreviated type name, polarity and Lot No.
- (3) Molding resin  
Epoxy resin           UL:V-0
- (4) Characteristics is shown   MS5D3003     10/12~12/12

Bar Code Label of EIAJ C-3 Specification. Indispensable description items are shown as below.

- (1) Type Name
- (2) Production Code
- (3) Quantity
- (4) Lot No.(Date code)
- (5) Company Code

**3. RATINGS**

**3.1 MAXIMUM RATINGS** (at Ta=25°C unless otherwise specified.)

ITEM	SYMBOL	CONDITIONS	RATINGS	UNITS
Repetitive peak reverse voltage	V <sub>RRM</sub>		300	V
Isolating voltage	V <sub>iso</sub>	Terminals-to-Case,AC.1min	1500	V
Average output current	I <sub>o</sub>	50Hz Square wave duty =1/2 T <sub>c</sub> = 96°C	20*	A
Non-repetitive forward surge current**	I <sub>FSM</sub>	Sine wave, 10ms 1shot	80	A
Operating junction temperature	T <sub>j</sub>		150	°C
Storage temperature	T <sub>stg</sub>		-40~+150	°C

\* Out put current of center tap full wave connection.

\*\* Rating per element

**3.2 ELECTRICAL** (at Ta=25°C unless otherwise specified.)

ITEM	SYMBOL	CONDITIONS	MAXIMUM	UNITS
Forward voltage ***	V <sub>F</sub>	I <sub>F</sub> = 10A	1.2	V
Reverse current ***	I <sub>R</sub>	V <sub>R</sub> = V <sub>RRM</sub>	200	μ A
Reverse recovery time***	trr	I <sub>F</sub> =0.1A,I <sub>R</sub> =0.2A,I <sub>rec</sub> =0.05A	0.04	μ s
Thermal resistance	R <sub>th(j-c)</sub>	Junction to case	2.0	°C/W

\*\*\* Rating per element

**3.3 MECHANICAL CHARACTERISTICS**

Mounting torque	Recommended torque	0.4~0.6	N·m
Approximate mass		6	g

This material and the information herein is the property of Fuji Electric Device Technology Co.,Ltd. They shall be neither reproduced, copied, lent, or disclosed in any way whatsoever for the use of any third party nor used for the manufacturing purposes without the express written consent of Fuji Electric Device Technology Co.,Ltd.

Fuji Electric Device Technology Co.,Ltd.

DWGNO.

MS5D3003 3/12

## 4. TEST AND INSPECTION

### 4.1 STANDARD TEST CONDITION

Standard test condition is Ta=25°C、65%R.H.

If judgment is no doubt, the test condition is possible to test in normal condition

Ta=5~35°C、48~85%R.H.

### 4.2 STRUCTURE INSPECTION

It inspect with eye and measure, Item 2 shall be satisfied.

### 4.3 FORWARD AND REVERSE CHARACTERISTICS

It inspect on the standard condition, Item 3.2 shall be satisfied.

### 4.4 TEST

	Test No.	Test Items	Testing methods and Conditions	Reference Standard EIAJ ED4701	Sampling number	Acceptance number
Mechanical test	1	Terminal Strength (Tensile)	Pull force : 25N Force maintaining duration :10±1s	EIAJ ED4701/401 method 1	5	(0 : 1)
	2	Terminal Strength (Bending)	Load force : 10N Number of times : 2times(90deg./time)	EIAJ ED4701/401 method 3	5	
	3	Mounting Strength	Screwing torque value:(M3) : 50±10N·cm	EIAJ ED4701/402 method 2	5	
	4	Vibration	Frequency : 100Hz to 2kHz Acceleration : 100m/s <sup>2</sup> Sweeping time : 4min./1 cycle 4times for each X, Y&Z directions.	EIAJ ED4701/403 test code D	5	
	5	Shock	Peak amplitude : 15km/s <sup>2</sup> Duration time : 0.5ms 3times for each X, Y&Z directions.	EIAJ ED4701/404 test code D	5	
	6	Solder ability 1	Solder : Sn-37Pb Solder temp. : 235±5°C Immersion time : 5±0.5s Apply to flux	EIAJ ED4701/303 test code A	5	
		Solder ability 2	Solder : Sn-3Ag-0.5Cu Solder temp. : 245±5°C Immersion time : 5±0.5s Apply to flux	—————	5	
7	Resistance to Soldering Heat	Solder temp. : 260±5°C Immersion time : 10±1s Number of times : 1times	EIAJ ED4701/302 test code A	5		

This material and the information herein is the property of Fuji Electric Device Technology Co.,Ltd. They shall be neither reproduced, copied, lent, or disclosed in any way whatsoever for the use of any third party nor used for the manufacturing purposes without the express written consent of Fuji Electric Device Technology Co.,Ltd.

This material and the information herein is the property of Fuji Electric Device Technology Co.,Ltd. They shall be neither reproduced, copied, lent, or disclosed in any way whatsoever for the use of any third party nor used for the manufacturing purposes without the express written consent of Fuji Electric Device Technology Co.,Ltd.

	Test No.	Test Items	Testing methods and Conditions	Reference Standard EIAJ ED4701	Sampling number	Acceptance number
<b>Endurance test</b>	1	High Temp. Storage	Temperature :Tstg max Test duration : 1000h	EIAJ ED4701/201	22	(0 : 1)
	2	Low Temp. Storage	Temperature :Tstg min Test duration : 1000h	EIAJ ED4701/202	22	
	3	Temperature Humidity Storage	Temperature : 85±2°C Relative humidity : 85±5% Test duration : 1000h	EIAJ ED4701/103 test code C	22	
	4	Temperature Humidity Bias	Temperature : 85±2°C Relative humidity : 85±5% Bias Voltage : V <sub>RRM</sub> × 0.8 Test duration : 1000h	EIAJ ED4701/103 test code C	22	
	5	Unsaturated Pressurized Vapor	Temperature : 130±2°C Relative humidity : 85±5% Vapor pressure : 230kPa Test duration : 48h	EIAJ ED4701/103 test code F	22	
	6	Temperature Cycle	High temp. side : Tstg max Room temp. : 5~35°C Low temp. side : Tstg min Duration time : HT 30min,RT 5min LT 30min Number of cycles : 100 cycles	EIAJ ED4701/105	22	
	7	Thermal Shock	Fluid : pure water(running water) High temp. side : 100+0/-5°C Low temp. side : 0+5/-0°C Duration time : HT 5min,LT 5min Number of cycles : 100 cycles	EIAJ ED4701/307 test code A	22	
	8	Steady state Operating life	T <sub>a</sub> =25±5°C Rated load Test duration : 1000h	—————	22	
	9	Intermittent Operating life	T <sub>j</sub> =T <sub>jmax</sub> ~50°C 3min ON, 3min OFF Test duration : 10000cycles	EIAJ ED4701/106	22	
	10	High Temp. Reverse Bias	Temperature : T <sub>a</sub> =100 °C Bias Voltage : V <sub>R</sub> =V <sub>RRM</sub> duty=1/2 Test duration : 1000h	EIAJ ED4701/101	22	

Failure Criteria	$I_R \leq USL \times 5$	USL : Upper specification Limit
	$V_F \leq USL \times 1.1$	

## 5.Cautions

- Although Fuji Electric is continually improving product quality and reliability, a small percentage of semiconductor products may become faulty. When using Fuji Electric semiconductor products in your equipment, you are requested to take adequate safety measures to prevent the equipment from causing physical injury, fire, or other problem in case any of the products fail. It is recommended to make your design fail-safe, flame retardant, and free of malfunction.
- The products described in this specification are intended for use in the following electronic and electrical equipment which has normal reliability requirements.
  - Computers    •OA equipment    •Communications equipment (Terminal devices)
  - Measurement equipment    •Machine tools    •AV equipment
  - Electrical home appliances    •Personal equipment    •Industrial robots etc.
- The products described in this Specification are not designed or manufactured to be used in equipment or systems used under life-threatening situations. If you are considering using these products in the equipment listed below, first check the system construction and required reliability, and take adequate safety measures such as a backup system to prevent the equipment from malfunctioning.
  - Transportation equipment (automobiles, trains, ships, etc.)
  - Backbone network equipment    •Traffic-signal control equipment
  - Gas alarms, leakage gas auto breakers    •Submarine repeater equipment
  - Burglar alarms, fire alarms, emergency equipment    •Medical equipment
  - Nuclear control equipment etc.
- Do not use the products in this Specification for equipment requiring strict reliability such as (but not limited to):
  - Aerospace equipment    •Aeronautical equipment

## 6.Warnings

- The Diodes should be used in products within their absolute maximum rating (voltage, current, temperature, etc. ). The diodes may be destroyed if used beyond the rating.
- The equipment containing Diodes should have adequate fuses or circuit breakers to prevent the equipment from causing secondary destruction (ex. fire, explosion etc...).
- Use the Diodes within their reliability and lifetime under certain environments or conditions.  
The Diodes may fail before the target lifetime of your products if used under certain reliability conditions.
- You must design the Diodes to be operated within the specified maximum ratings (voltage, current, temperature, etc. ) to prevent possible failure or destruction of devices.
- Consider the possible temperature rise not only for the junction and case, but also for the outer leads.
- Do not directly touch the leads or package of the Diodes while power is supplied or during operation, to avoid electric shock and burns.
- The Diodes are made of incombustible material. However, if a Diode fails, it may emit smoke or flame. Also, operating the Diodes near any flammable place or material may cause the Diodes to emit smoke or flame in case the Diodes become even hotter during operation.  
Design the arrangement to prevent the spread of fire.
- The Diodes should not used in an environment in the presence of acid, organic matter, or corrosive gas. (hydrogen sulfide, sulfurous acid gas.)
- The Diodes should not used in an irradiated field since they are not radiation proof.

## Installation

- Soldering involves temperatures which exceed the device storage temperature rating. To avoid device damage and to ensure reliability, observe the following guidelines from the quality assurance standard.

Table 1: Solder temperature and duration

Method	Solder temperature	Duration
Flow	260±5°C	10±1sec
Soldering iron	350±10°C	3.5±0.5sec

- The immersion depth of the lead should basically be up to the lead stopper and the distance should be a maximum of 1.5mm from the device.
- When flow-soldering, be careful to avoid immersing the package in the solder bath.
- Refer to the following torque reference When mounting the device on a heat sink. Excess torque applied to the mounting screw causes damage to the device and weak torque will increase the thermal resistance, both of which conditions may destroy the device.

Table 2: Recommended tightening torque

Package style	Screw	Recommended tightening torque
TO-3PF	M3	0.4~0.6N·m

- The heat sink should have a flatness within  $\pm 30 \mu\text{m}$  and roughness within  $10 \mu\text{m}$ . Also, keep the tightening torque within the limits of this specification.
- Improper handling may cause isolation breakdown leading to a critical accident.
- We recommend the use of thermal compound to optimize the efficiency of heat radiation. It is important to evenly apply the compound and to eliminate any air voids.

## Storage

- The Diodes must be stored at a standard temperature of 5 to 35°C and relative humidity of 45 to 75%. If the storage area is very dry, a humidifier may be required. In such a case, use only deionized water or boiled water, since the chlorine in tap water may corrode the leads.
- The Diodes should not be subjected to rapid changes in temperature to avoid condensation on the surface of the Diodes. Therefore, store the Diodes in a place where the temperature is steady.
- The Diodes should not be stored on top of each other, since this may cause excessive external force on the case.
- The Diodes should not be stored with the lead terminals remaining unprocessed. Rust may cause presoldered connections to go fail during later processing.
- The Diodes should be stored in antistatic containers or shipping bags.

## **7.Appendix**

- This products does not contain PBBs (Polybrominated Biphenyl) or PBDEs (Polybrominated Diphenyl Ether ) , substances.
- This products does not contain Class-I ODS and Class-II ODS substances set force by 'Clean Air Act of US' law.

- If you have any questions about any part of this Specification, please contact Fuji Electric Device Technology or its sales agent before using the product
- Neither Fuji nor its agents shall be held liable for any injury caused by using the products not in accordance with the instructions.
- The application examples described in this specification are merely typical uses of Fuji Electric DeviceTechnology products.  
This specification does not confer any industrial property rights or other rights, nor constitute a license for such rights.

This material and the information herein is the property of Fuji Electric Device Technology Co.,Ltd. They shall be neither reproduced, copied, lent, or disclosed in any way whatsoever for the use of any third party nor used for the manufacturing purposes without the express written consent of Fuji Electric Device Technology Co.,Ltd.



# FUJI SILICON DIODE

TYPE : ESAD92M-□□RR

## OUT VIEW

外形寸法図

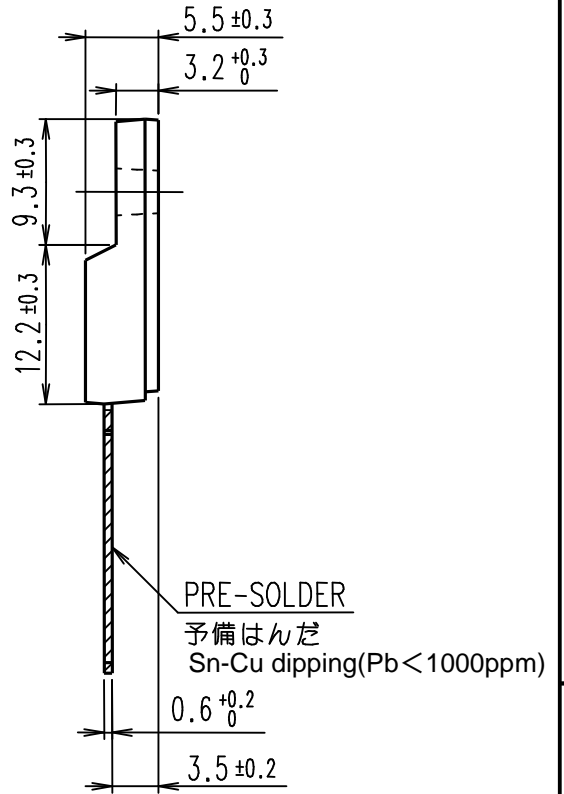
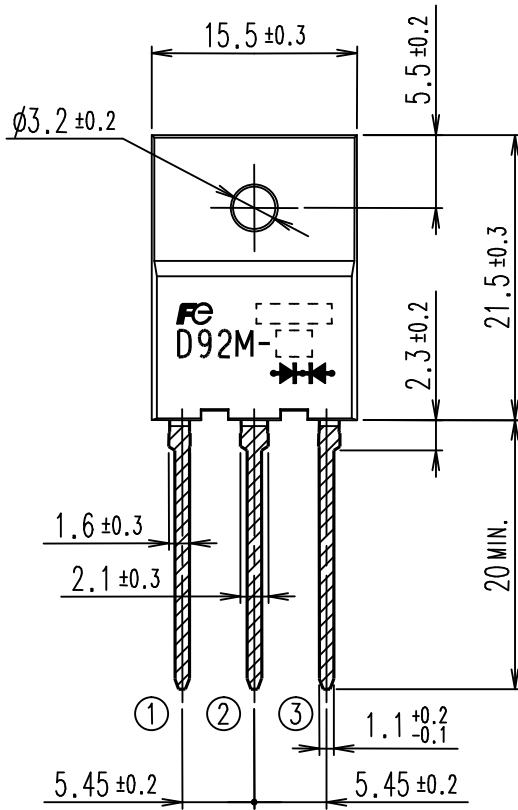

## MARKING

表示内容

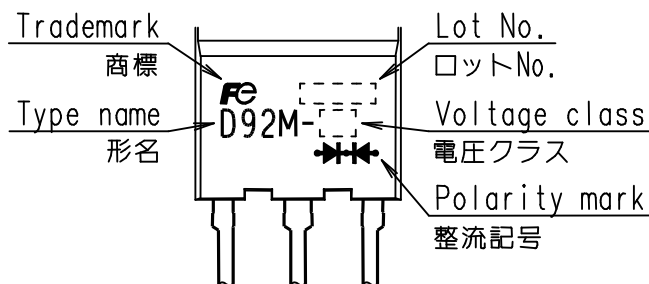

## CONNECTION

結線図

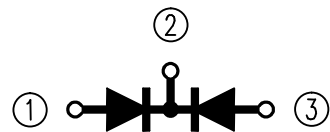

UNIT : mm  
寸法単位 : mm

This material and the information herein is the property of Fuji Electric Device Technology Co., Ltd. They shall be neither reproduced, copied, lent, or disclosed in any way whatsoever for the use of any third party nor used for the manufacturing purposes without the express written consent of Fuji Electric Device Technology Co., Ltd.

This material and the information herein is the property of Fuji Electric Device Technology Co.,Ltd. They shall be neither reproduced, copied, lent, or disclosed in any way whatsoever for the use of any third party nor used for the manufacturing purposes without the express written consent of Fuji Electric Device Technology Co.,Ltd.

Forward Characteristic (typ.)

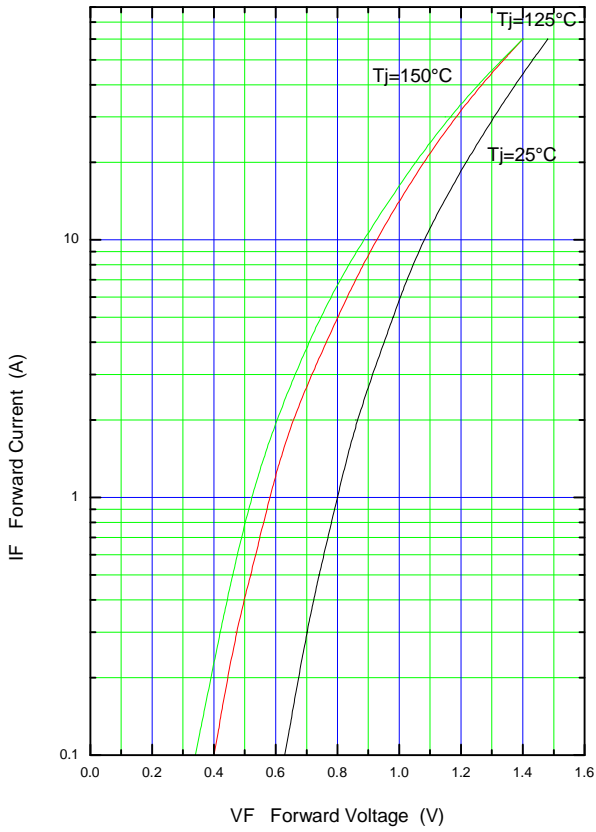

Reverse Characteristic (typ.)

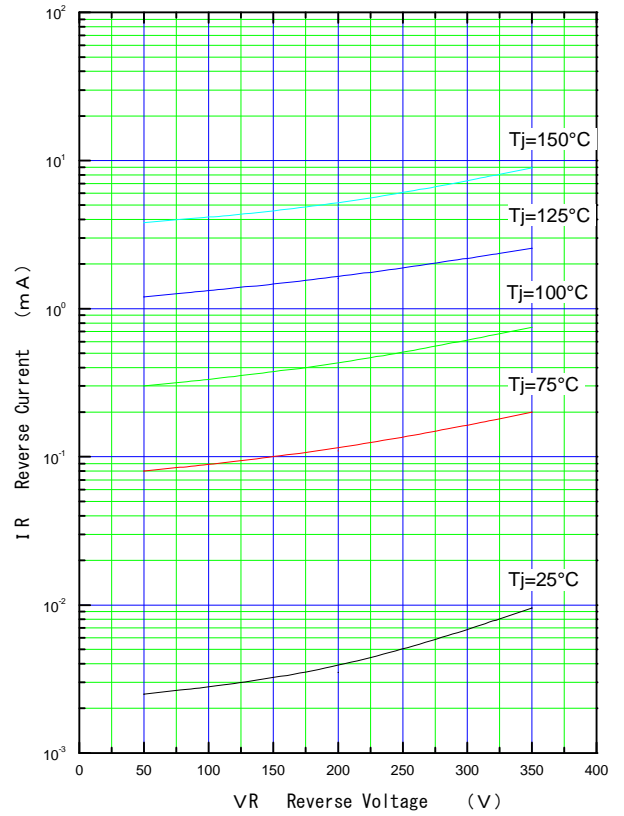

Forward Power Dissipation (max.)

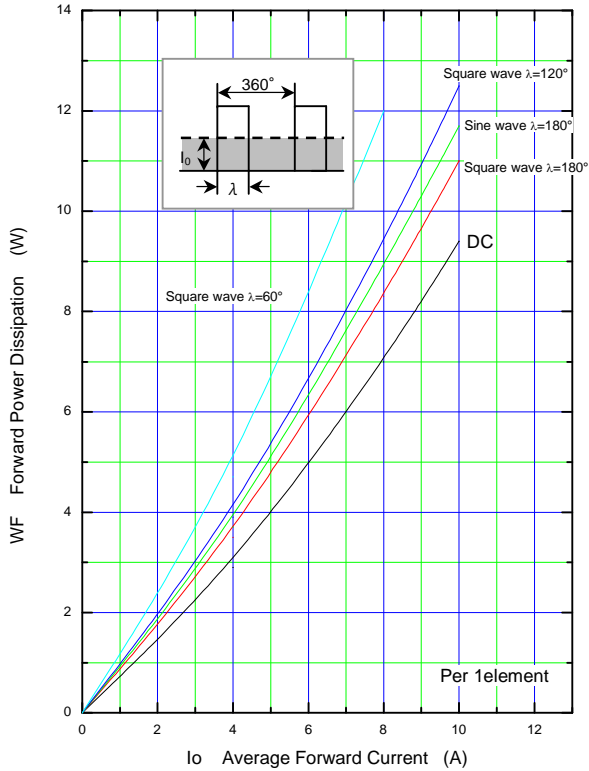

Reverse Power Dissipation (max.)

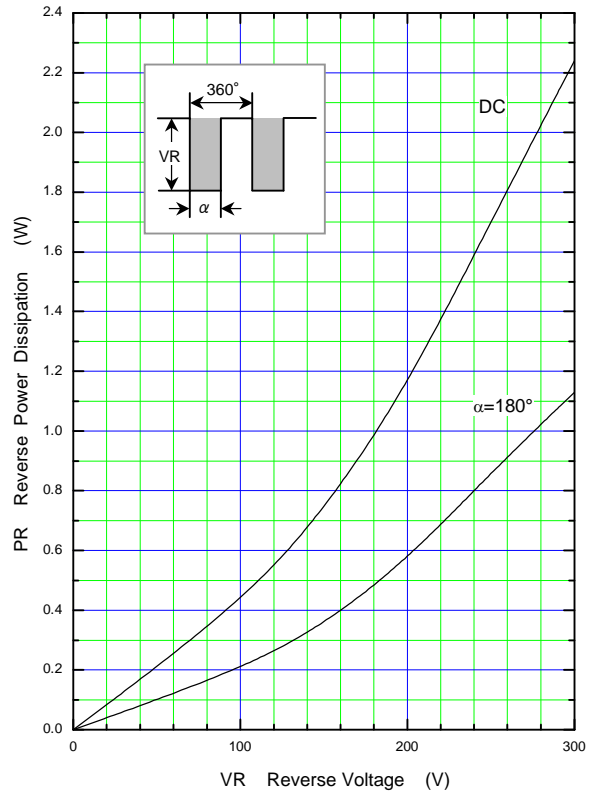

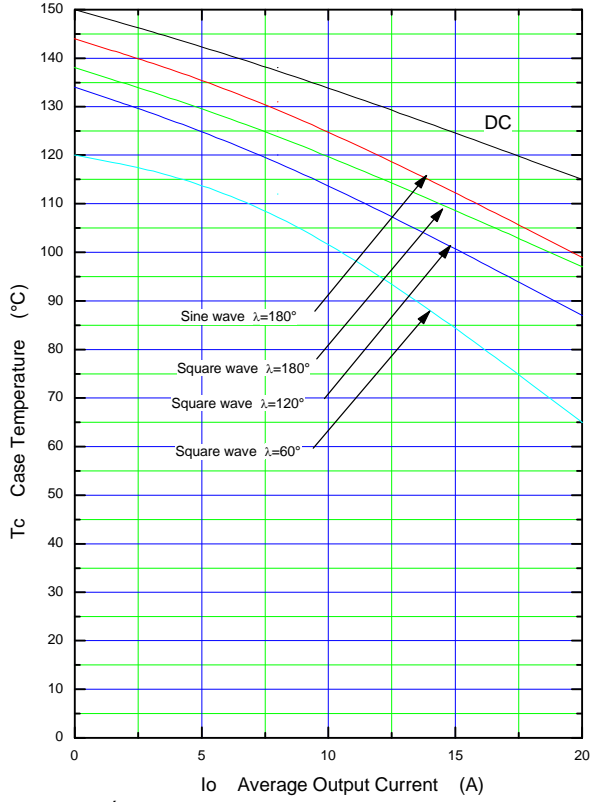

This material and the information herein is the property of Fuji Electric Device Technology Co.,Ltd. They shall be neither reproduced, copied, lent, or disclosed in any way whatsoever for the use of any third party nor used for the manufacturing purposes without the express written consent of Fuji Electric Device Technology Co.,Ltd.

**Current Derating (Io-Tc) (max.)**

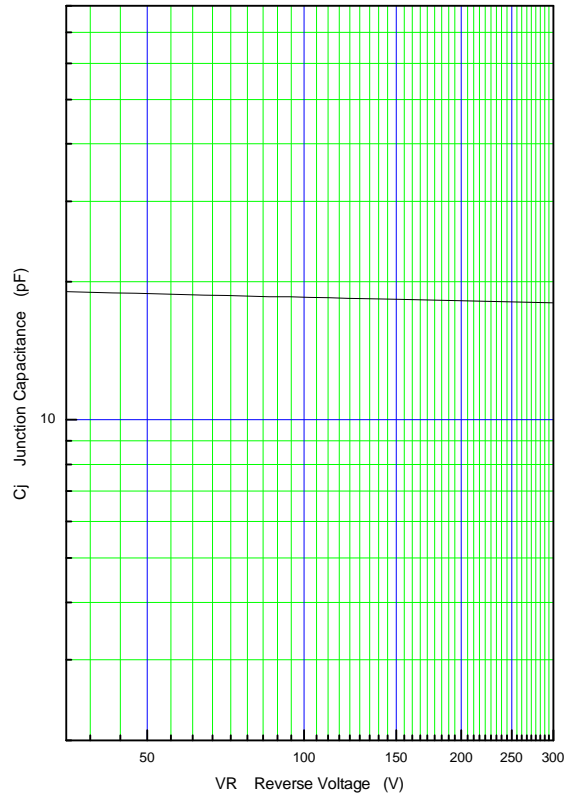

$f$ : Conduction angle of forward current for each rectifier element  
 $I_o$ : Output current of center-tap full wave connection

**Junction Capacitance Characteristic (typ.)**



**Surge Capability (max.)**

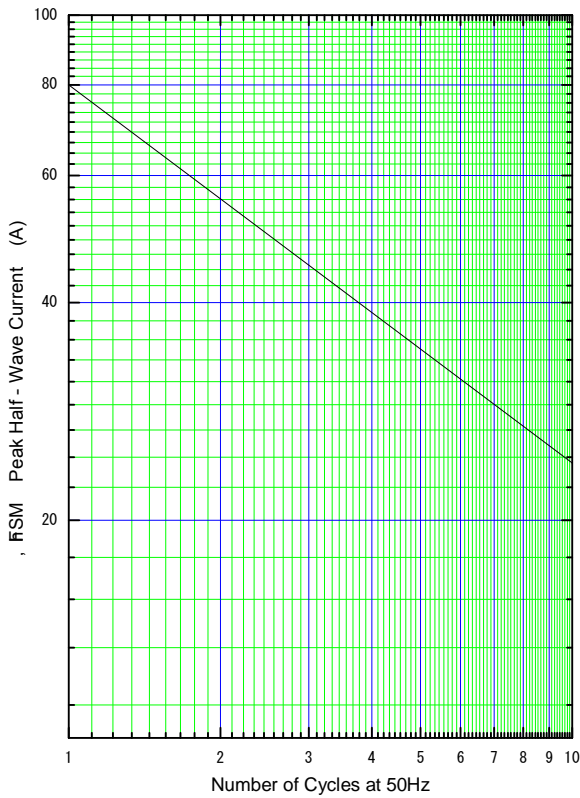

This material and the information herein is the property of Fuji Electric Device Technology Co.,Ltd. They shall be neither reproduced, copied, lent, or disclosed in any way whatsoever for the use of any third party nor used for the manufacturing purposes without the express written consent of Fuji Electric Device Technology Co.,Ltd.

